**Features**

- APD with 0.008 mm<sup>2</sup> active area
- Optimized for 550 nm to 750 nm
- Very high sensitivity
- High cut-off frequency
- Ultra low temperature coefficient

**Description**

Circular active area APD chip with 100 μm diameter. Metal can type hermetic TO52S1 package with clear glass window.

**Application**

- Laser range finder
- High speed photometry
- High speed optical communications
- Medical equipment

**RoHS**

2002/95/EC

**Absolute maximum ratings**

Symbol	Parameter	Min	Max	Unit
T <sub>STG</sub>	Storage temp	-55	125	°C
T <sub>OP</sub>	Operating temp	-40	100	°C
M <sub>max</sub>	Gain (I <sub>PO</sub> = 1 nA)	200		
I <sub>PEAK</sub>	Peak DC current		0.25	mA

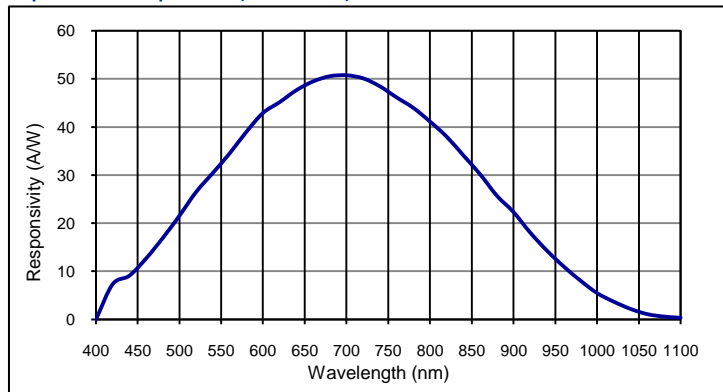
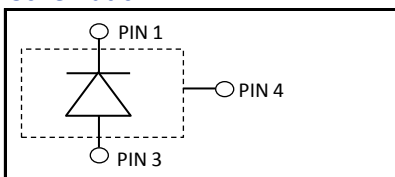
**Spectral response (M = 100)**

**Schematic**

**Electro-optical characteristics @ 23°C**

Symbol	Characteristic	Test Condition	Min	Typ	Max	Unit
	Active area		diameter 100			μm
	Active area		0.0078			mm <sup>2</sup>
I <sub>D</sub>	Dark current	M = 100		0.05	0.5	nA
C	Capacitance	M = 100		0.5		pF
	Responsivity	M = 100; λ = 660 nm	45	50		A/W
t <sub>R</sub>	Rise time	M = 100; λ = 660 nm; R <sub>L</sub> = 50 Ω		0.12		ns
	Cut-off frequency	-3dB, phase shift mode		3		GHz
V <sub>BR</sub>	Breakdown voltage	I <sub>R</sub> = 2 μA, V <sub>BR</sub> - binning available	60	90	120	V
	Temperature coefficient	Change of V <sub>BR</sub> with temperature		0.2		V/K
	Excess noise factor	M = 100		2.0		
	Excess noise index	M = 100		0.15		

**European, International Sales:**

First Sensor AG  
 Peter-Behrens-Strasse 15  
 12459 Berlin  
 Germany  
 T +49 30 6399 2399  
 F +49 30 639923-752  
 sales.opto@first-sensor.com

**USA:**

First Sensor Inc.  
 5700 Corsa Avenue #105  
 Westlake Village  
 CA 91362 USA  
 T +1 818 706 3400  
 F +1 818 889 7053  
 sales.us@first-sensor.com

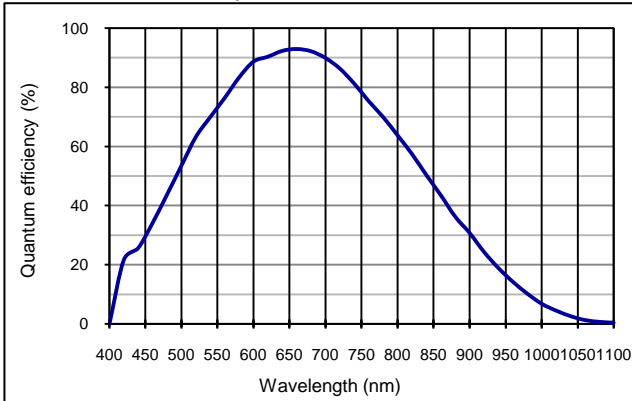
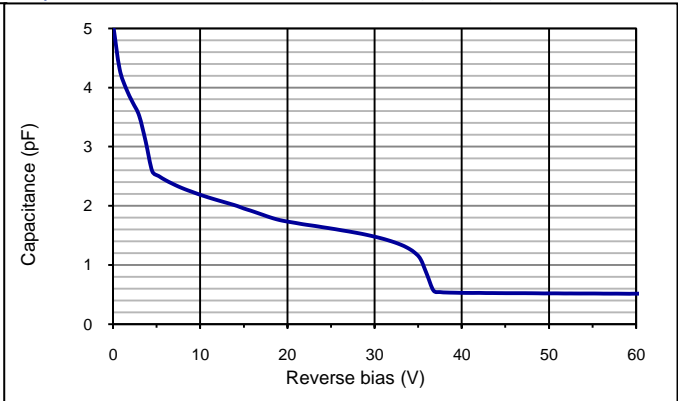
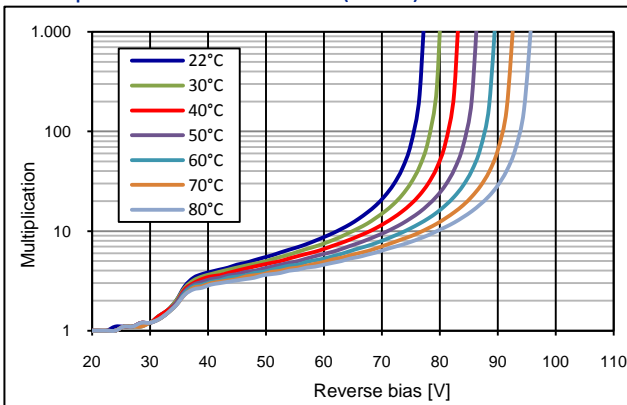
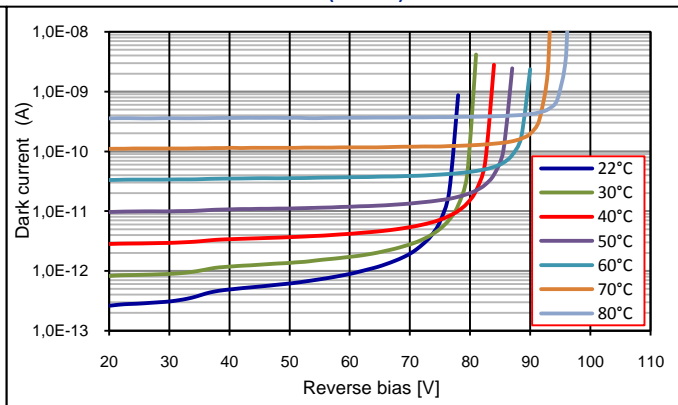
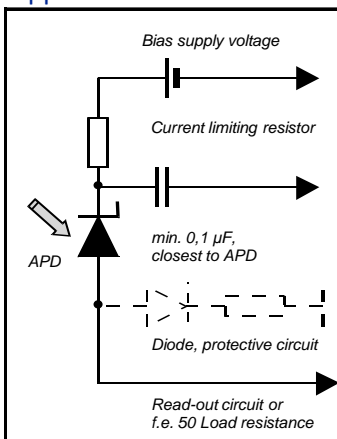
**Quantum efficiency (23 °C)**

**Capacitance as fct of reverse bias (23 °C)**

**Multiplication as fct of bias (23 °C)**

**Dark current as fct of bias (23 °C)**

**Application hints:**

- Current should be limited by a protecting resistor or current limiting - IC inside the power supply
- For low light level applications blocking of ambient light should be used
- For high gain applications bias voltage should be temperature compensated
- Please consider basic ESD protection while handling
- Use low noise read-out - IC
- For further questions please refer to document "Instructions for handling and processing"

**Package dimension:**

Small quantities: Foam pad, boxed (12 cm x 16.5 cm)

Disclaimer: Due to our strive for continuous improvement, specifications are subject to change within our PCN policy according to JESD46C.

**European, International Sales:**

 First Sensor AG  
 Peter-Behrens-Strasse 15  
 12459 Berlin  
 Germany  
 T +49 30 6399 2399  
 F +49 30 639923-752  
 sales.opto@first-sensor.com

**USA:**

 First Sensor Inc.  
 5700 Corsa Avenue #105  
 Westlake Village  
 CA 91362 USA  
 T +1 818 706 3400  
 F +1 818 889 7053  
 sales.us@first-sensor.com