

Features

- APD with 0.04 mm² active area
- 230 μm diameter active area
- High gain at low bias voltage
- Fast rise time, low capacitance
- Optimum gain: 50-60

Description

Circular active area APD chip with 230 μm diameter. Ceramic carrier type non hermetic SMD package with clear glass or filter window. Reflow solderable.

Application

- Laser range finder
- High speed photometry
- High speed optical communications
- Medical equipment

RoHS

2002/95/EC



Absolute maximum ratings

Symbol	Parameter	Min	Max	Unit
T _{STG}	Storage temp	-40	100	°C
T _{OP}	Operating temp	-20	70	°C
M _{max}	Gain (I _{PO} = 1 nA)	200		
I _{PEAK}	Peak DC current		0.25	mA

Schematic

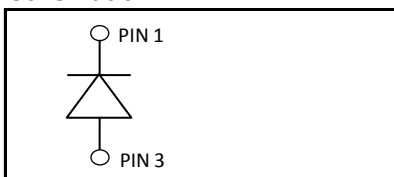

Spectral response (M = 100)

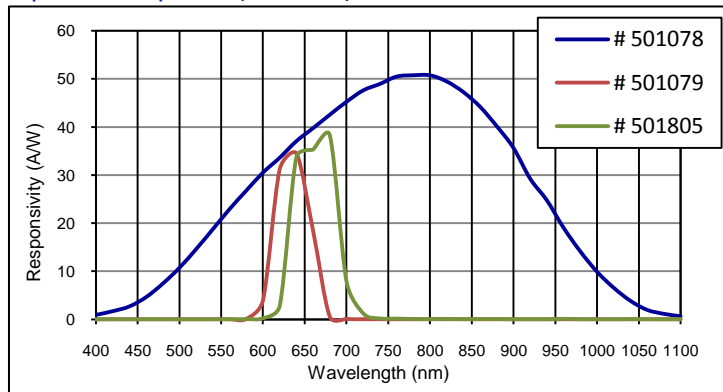

Electro-optical characteristics @ 23 °C

Symbol	Characteristic	Test Condition	Min	Typ	Max	Unit
	Active area		diameter 230			μm
	Active area		0.04			mm ²
I _D	Dark current	M = 100		0.3	1.0	nA
C	Capacitance	M = 100		1.2		pF
	Responsivity	Order # 501078 ; M = 100; λ = 800 nm	45	50		A/W
	Responsivity	Order # 501079 ; M = 100; λ = 635 nm	30	32		A/W
	Responsivity, preliminary	Order # 501805 ; M = 100; λ = 650 nm	30	35		A/W
t _R	Rise time	M = 100; λ = 905 nm; R _L = 50 Ω		0.18		ns
	Cut-off frequency	-3dB		2		GHz
V _{BR}	Breakdown voltage	I _R = 2 μA, V _{BR} - binning available*	80		160	V
	Temperature coefficient	Change of V _{BR} with temperature		0.45		V/K
	Excess noise factor	M = 100		2.2		
	Excess noise index	M = 100		0.2		

*please add a "01" to the order number for VBR-class 80V-120V and a "02" for VBR-class 120V-160V

European, International Sales:



First Sensor AG
 Peter-Behrens-Strasse 15
 12459 Berlin
 Germany
 T +49 30 6399 2399
 F +49 30 639923-752
 sales.opto@first-sensor.com

USA:



First Sensor Inc.
 5700 Corsa Avenue #105
 Westlake Village
 CA 91362 USA
 T +1 818 706 3400
 F +1 818 889 7053
 sales.us@first-sensor.com

Quantum efficiency (23 °C)

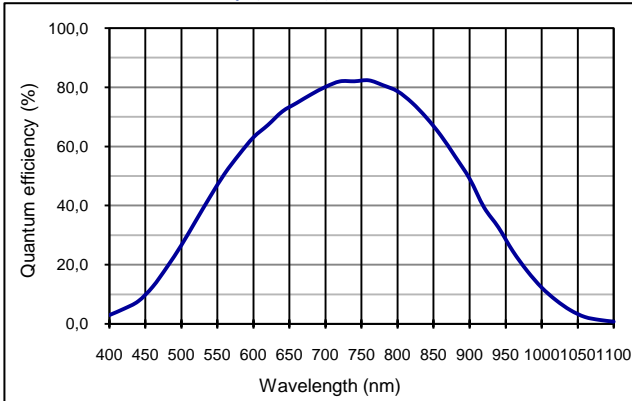

Capacitance as fct of reverse bias (23 °C)

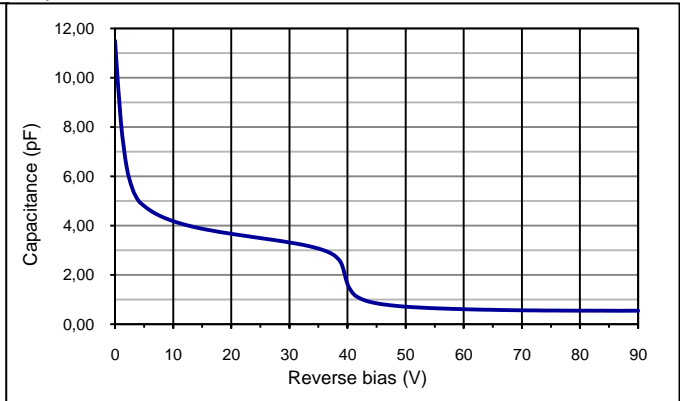

Multiplication as fct of bias and temperature

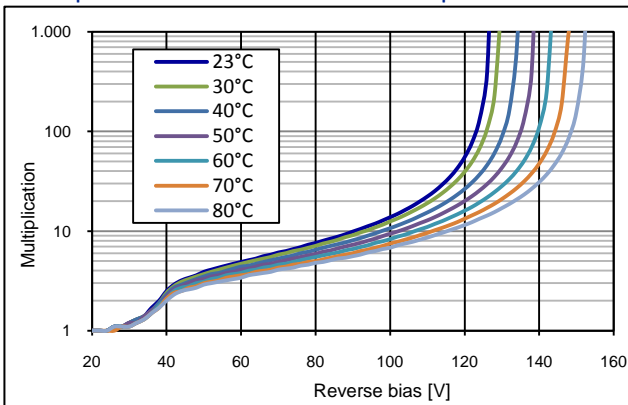

Dark current as fct of bias and temperature

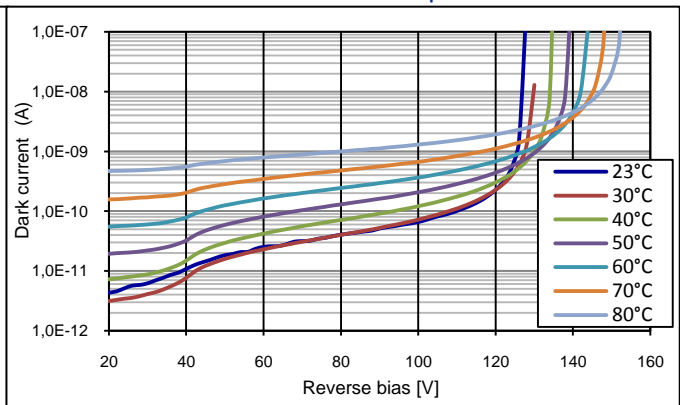

Order # 501079:

Typ. filter characteristics (center 635 nm)

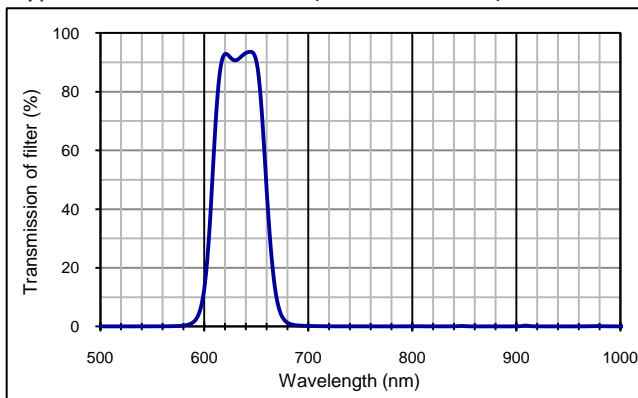

full filter specification upon request

Order # 501805:

Typ. filter characteristics (center 650 nm)

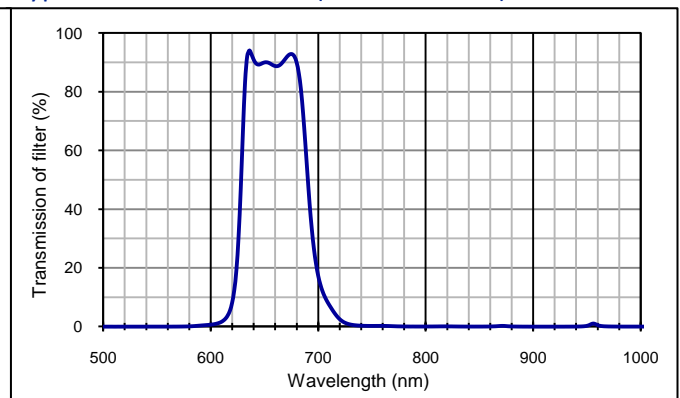

full filter specification upon request

European, International Sales:



First Sensor AG
 Peter-Behrens-Strasse 15
 12459 Berlin
 Germany
 T +49 30 6399 2399
 F +49 30 639923-752
 sales.opto@first-sensor.com

USA:



First Sensor Inc.
 5700 Corsa Avenue #105
 Westlake Village
 CA 91362 USA
 T +1 818 706 3400
 F +1 818 889 7053
 sales.us@first-sensor.com

Technical Drawing, Package: LCC6.1

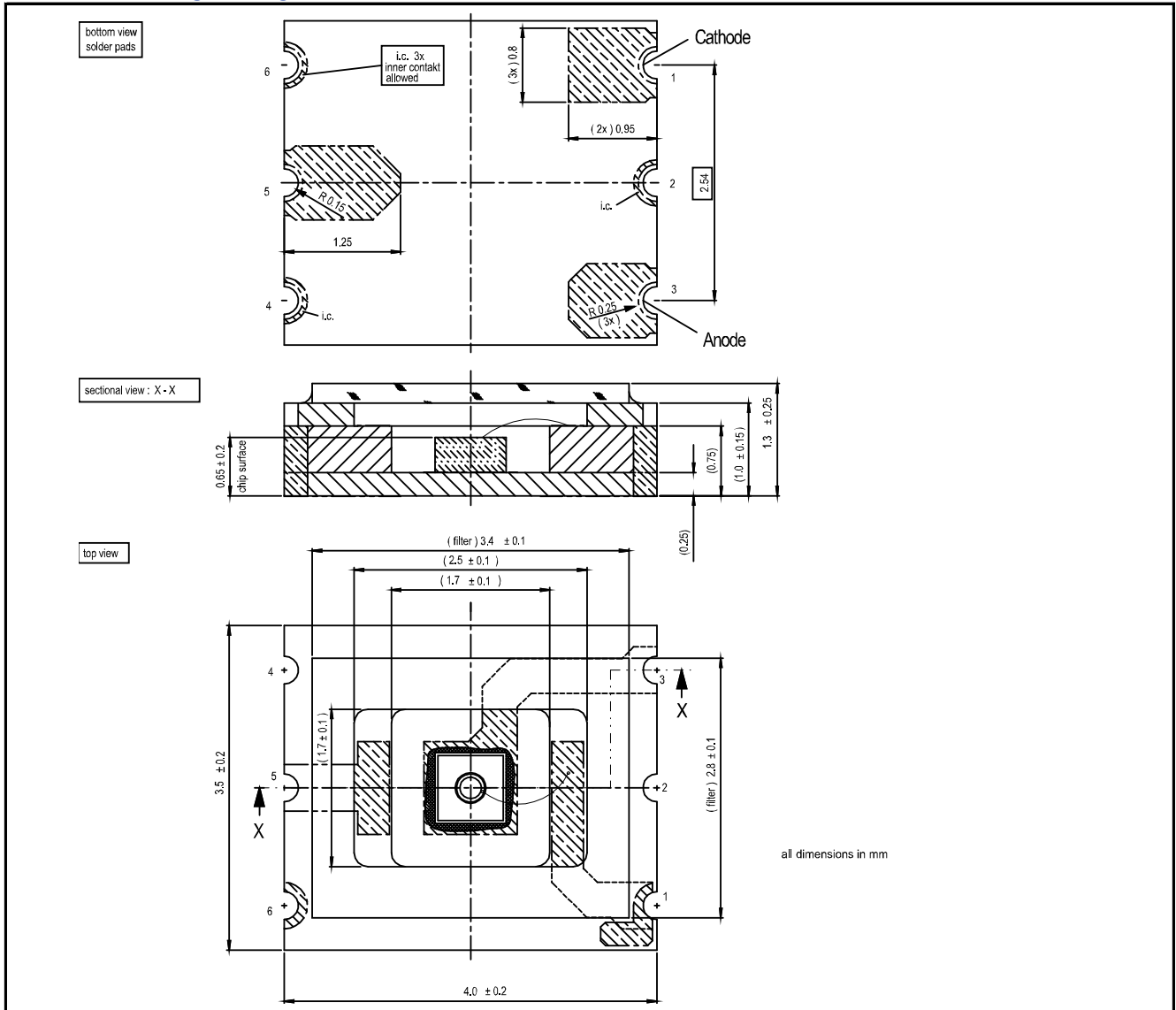

Application hints:

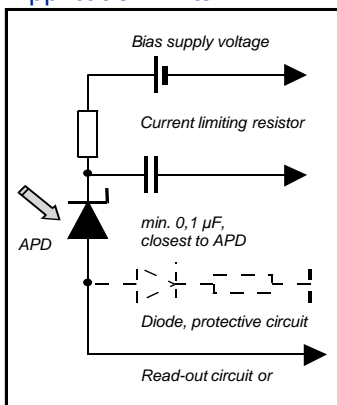

- Current should be limited by a protecting resistor or current limiting - IC inside the power supply
- For low light level applications blocking of ambient light should be used
- For high gain applications bias voltage should be temperature compensated
- Please consider basic ESD protection while handling
- Use low noise read-out - IC
- For further questions please refer to document "Instructions for handling and processing"
- Optimum gain: 50-60

European, International Sales:



First Sensor AG
 Peter-Behrens-Strasse 15
 12459 Berlin
 Germany
 T +49 30 6399 2399
 F +49 30 639923-752
 sales.opto@first-sensor.com

USA:



First Sensor Inc.
 5700 Corsa Avenue #105
 Westlake Village
 CA 91362 USA
 T +1 818 706 3400
 F +1 818 889 7053
 sales.us@first-sensor.com

Package dimension, large quantities on reel

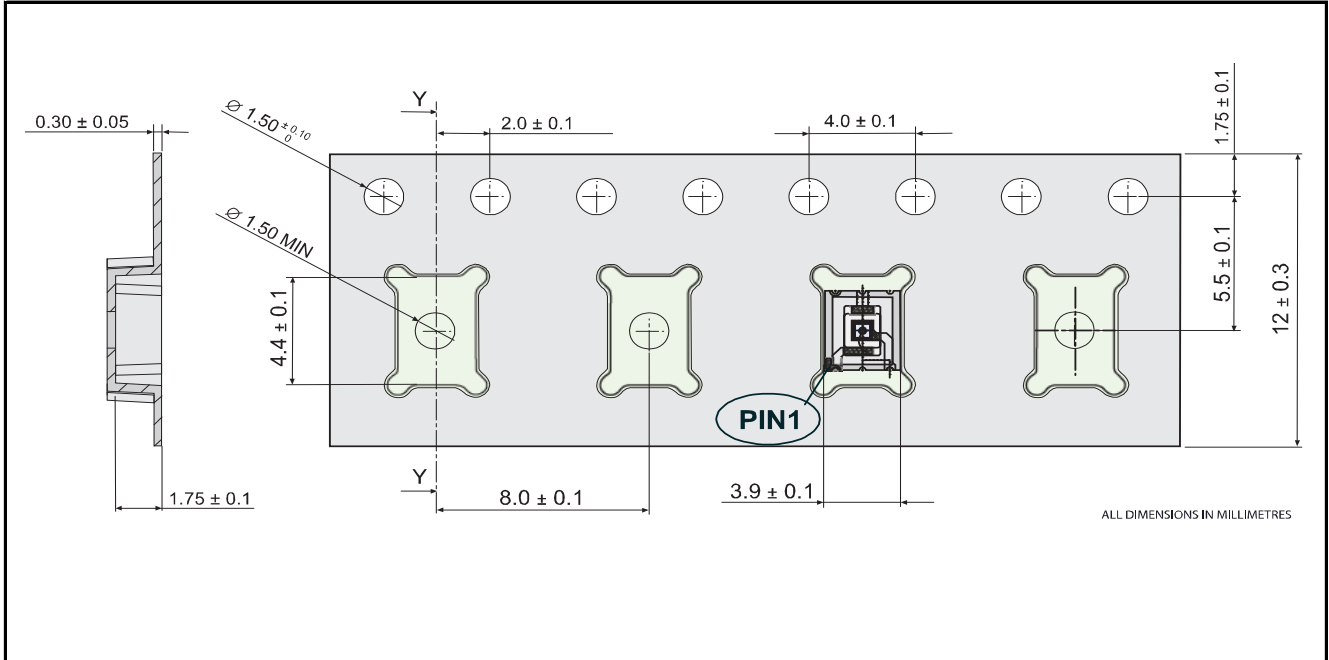

Package dimension, small quantities in trays

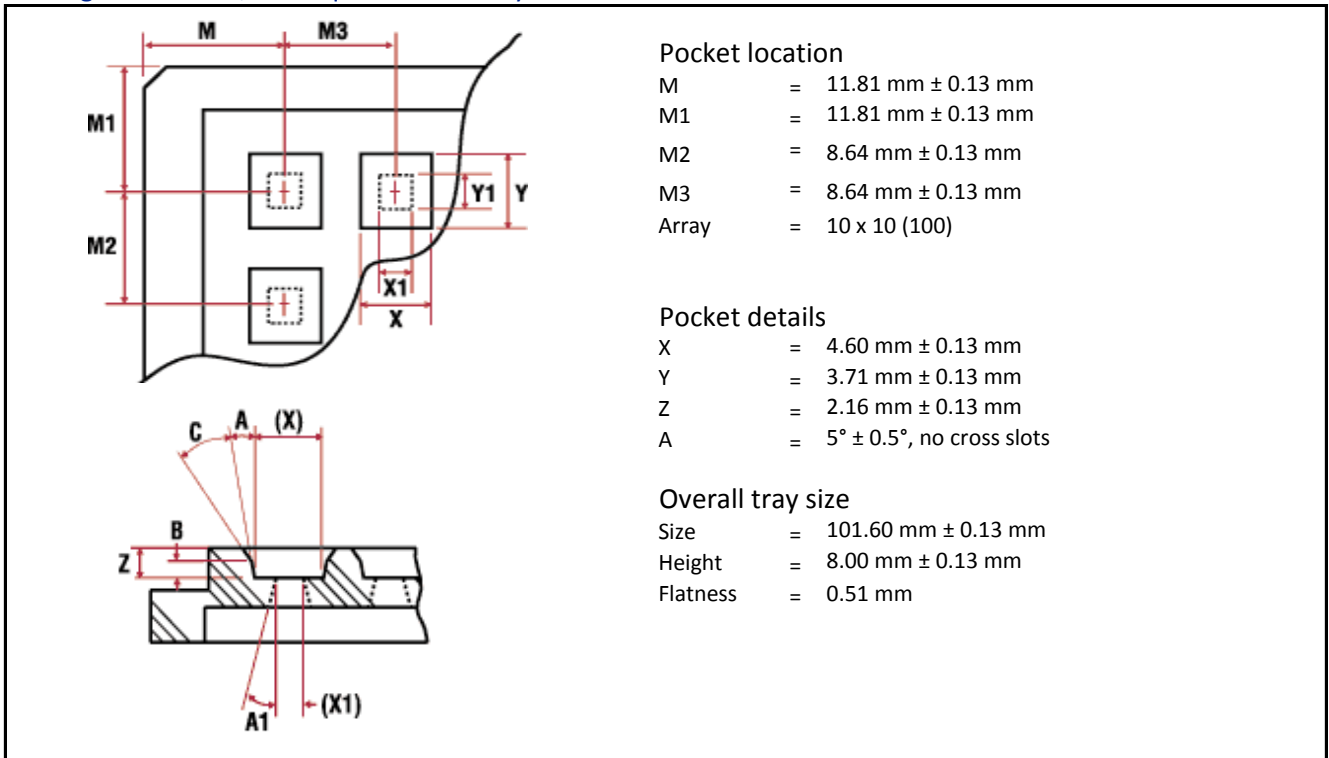

Disclaimer: Due to our strive for continuous improvement, specifications are subject to change within our PCN policy according to JESD46C.

European, International Sales:



First Sensor AG
 Peter-Behrens-Strasse 15
 12459 Berlin
 Germany
 T +49 30 6399 2399
 F +49 30 639923-752
 sales.opto@first-sensor.com

USA:



First Sensor Inc.
 5700 Corsa Avenue #105
 Westlake Village
 CA 91362 USA
 T +1 818 706 3400
 F +1 818 889 7053
 sales.us@first-sensor.com