Features

- 500 μm x 500 μm active area
- Low dark current
- Fast response time
- High speed epitaxy

Description

High speed epitaxy PIN photodiode with 0.25 mm² square active area. Metal can type hermetic TO52 package with clear glass window. Two TO52 types available, customization on request.

Application

- Pulsed light detection
- High speed photometry
- High speed optical communications
- Fiber optic light monitoring

RoHS

2002/95/EC

Absolute maximum ratings

Symbol	Parameter	Min	Max	Unit
T _{STG}	Storage temp	-55	125	°C
T _{OP}	Operating temp	-40	100	°C
V _{max}	Max reverse voltage		30	V
I _{PEAK}	Peak DC current		10	mA

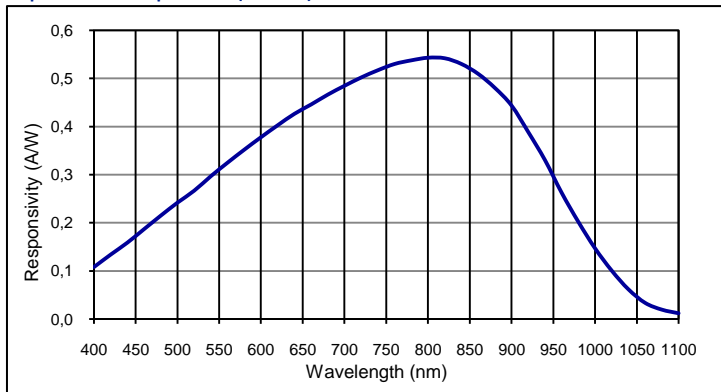
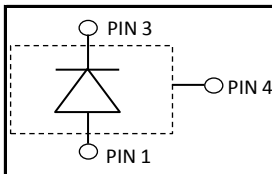
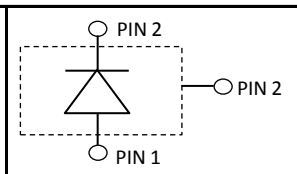
Spectral response (23 °C)

Schematic 500122

Schematic 500119

Electro-optical characteristics @ 23 °C

Symbol	Characteristic	Test Condition	Min	Typ	Max	Unit
	Active area		500 x 500			μm
	Active area		0.25			mm ²
I _D	Dark current	V _R = 20 V		0.1		nA
C	Capacitance	V _R = 0 V		6		pF
C	Capacitance	V _R = 20 V		1.8		pF
	Responsivity	λ = 635 nm		0.4		A/W
	Responsivity	λ = 800 nm		0.52		A/W
t _R	Rise time	V _R = 20 V; λ = 850 nm; R _L = 50 Ω		0.4		ns
V _{BR}	Breakdown voltage	I _R = 2 μA	30	50		V
	Shunt resistance	V _R = 10 mV		1000		MΩ
	N.E.P.	V _R = 20 V; λ = 850 nm		1.1 E-14		W/√Hz

European, International Sales:

First Sensor AG
 Peter-Behrens-Strasse 15
 12459 Berlin
 Germany
 T +49 30 6399 2399
 F +49 30 639923-752
 sales.opto@first-sensor.com

USA:

First Sensor Inc.
 5700 Corsa Avenue #105
 Westlake Village
 CA 91362 USA
 T +1 818 706 3400
 F +1 818 889 7053
 sales.us@first-sensor.com

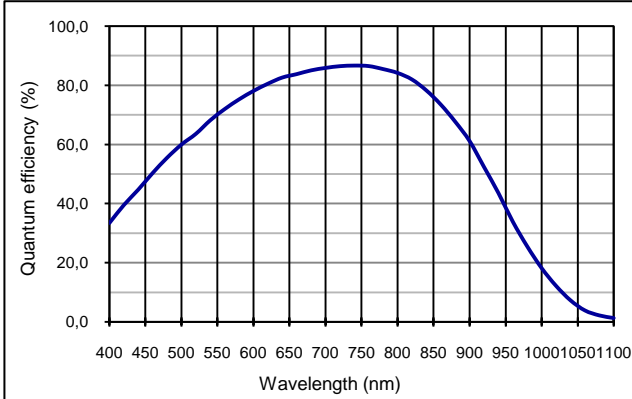
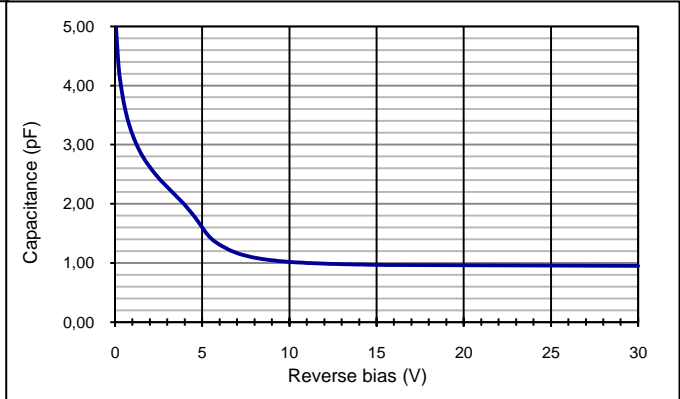
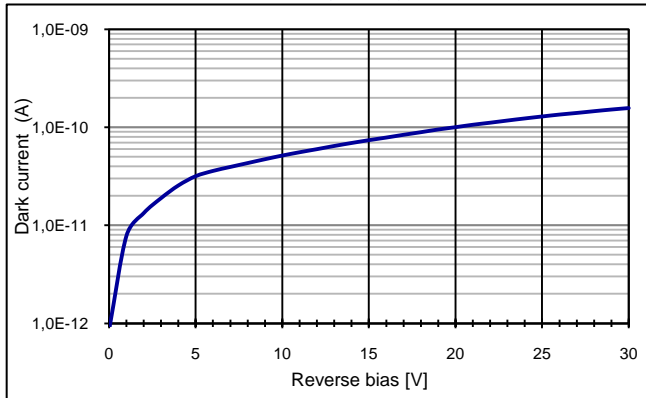
Quantum efficiency (23 °C)

Capacitance as fct of reverse bias (23 °C)

Dark current as fct of bias (23 °C)

Application hints:

Please refer to document "Instructions for handling and processing"

Package dimension:

Small quantities: Foam pad, boxed (12 cm x 16.5 cm)

European, International Sales:

First Sensor AG
 Peter-Behrens-Strasse 15
 12459 Berlin
 Germany
 T +49 30 6399 2399
 F +49 30 639923-752
 sales.opto@first-sensor.com

USA:

First Sensor Inc.
 5700 Corsa Avenue #105
 Westlake Village
 CA 91362 USA
 T +1 818 706 3400
 F +1 818 889 7053
 sales.us@first-sensor.com

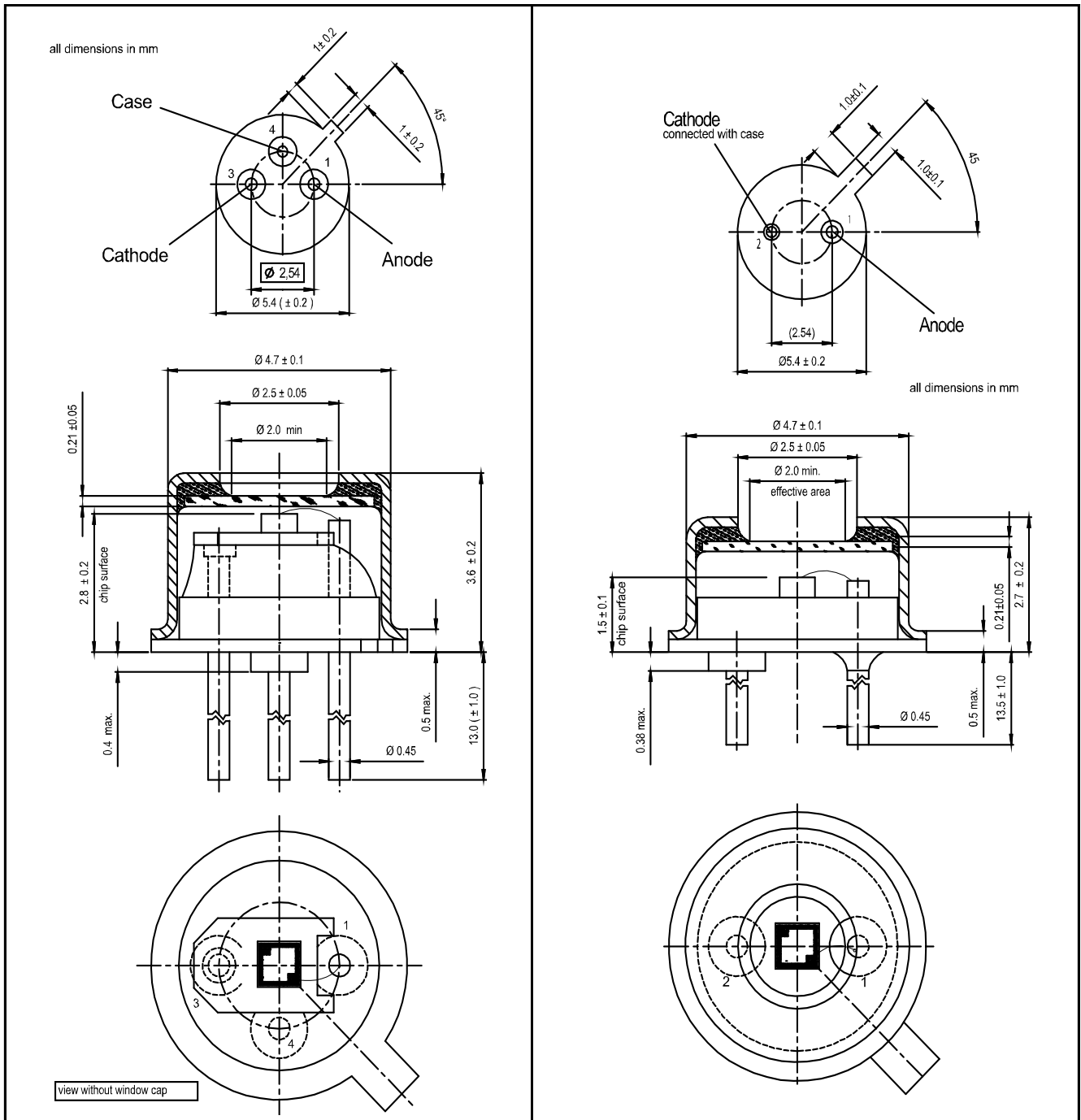
Technical Drawing, Package: TO52
TO52S1 #500122
TO52S3 #500119

Disclaimer: Due to our strive for continuous improvement, specifications are subject to change within our PCN policy according to JESD46C.

European, International Sales:

 First Sensor AG
 Peter-Behrens-Strasse 15
 12459 Berlin
 Germany
 T +49 30 6399 2399
 F +49 30 639923-752
 sales.opto@first-sensor.com

USA:

 First Sensor Inc.
 5700 Corsa Avenue #105
 Westlake Village
 CA 91362 USA
 T +1 818 706 3400
 F +1 818 889 7053
 sales.us@first-sensor.com