Features

- InGaAs technology
- 0.7 mm² PIN detector
- High sensitivity up to 1700 nm
- Low dark current

Description

Low dark current InGaAs PIN photodiode with circular 0.7 mm² active area. Metal can type hermetic TO52 package with clear glass window.

Application

- Precision photometry
- Analytical instruments
- Medical equipment
- Pulsed light detector
- Eyesafe laser light detector

RoHS

2002/95/EC

Absolute maximum ratings

Symbol	Parameter	Min	Max	Unit
T _{STG}	Storage temp	-40	85	°C
T _{OP}	Operating temp	-20	85	°C
V _{max}	Max reverse voltage		20	V
I _{PEAK}	Peak DC current		10	mA

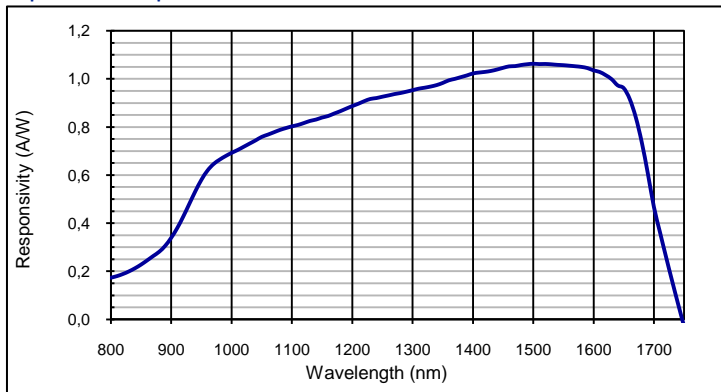
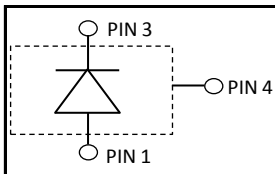
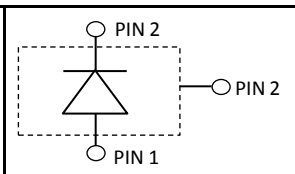
Spectral response

Schematic 501203

Schematic TO52S3

Electro-optical characteristics @ 23°C

Symbol	Characteristic	Test Condition	Min	Typ	Max	Unit
	Active area		diameter 950			µm
	Active area		0.71			mm ²
I _D	Dark current	V _R = 5 V		1	10	nA
C	Capacitance	V _R = 0 V		140	200	pF
		V _R = 5 V		70	100	pF
	Responsivity	λ = 650 nm	0.02	0.05		A/W
		λ = 850 nm	0.10	0.20		A/W
		λ = 1310 nm	0.80	0.90		A/W
		λ = 1550 nm	0.85	0.95		A/W
t _R	Rise time	V _R = 5 V; λ = 1550 nm; R _L = 50 Ω		15		ns
	Shunt Resistance	V _R = 5 mV	25	80		MΩ
	Saturation power	V _R = 0 V; λ = 1550 nm; R _L = 50 Ω		-3		dbm
D*	Detectivity	V _R = 0 V; λ = 1550 nm; R _L = 50 Ω	2.5 E12	5 E12		Jones
V _{BR}	Breakdown voltage	I _R = 2 µA	20	30		V

European, International Sales:

First Sensor AG
 Peter-Behrens-Strasse 15
 12459 Berlin
 Germany
 T +49 30 6399 2399
 F +49 30 639923-752
 sales.opto@first-sensor.com

USA:

First Sensor Inc.
 5700 Corsa Avenue #105
 Westlake Village
 CA 91362 USA
 T +1 818 706 3400
 F +1 818 889 7053
 sales.us@first-sensor.com

Quantum efficiency (23 °C)

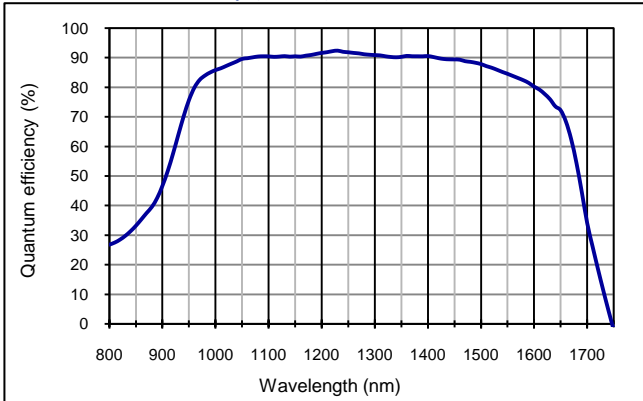

Capacitance as fct of reverse bias (23 °C)

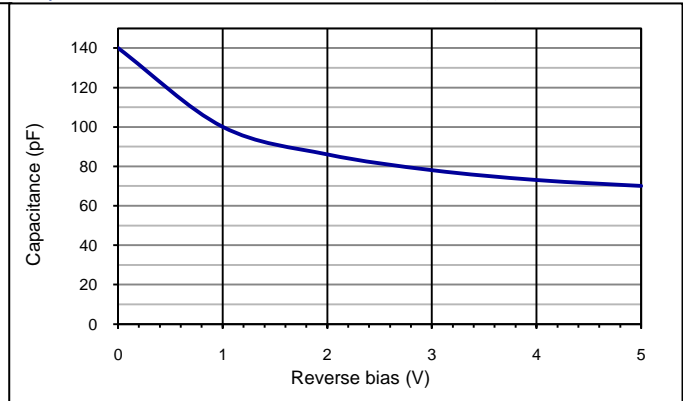

Dark current as fct of bias (23 °C)

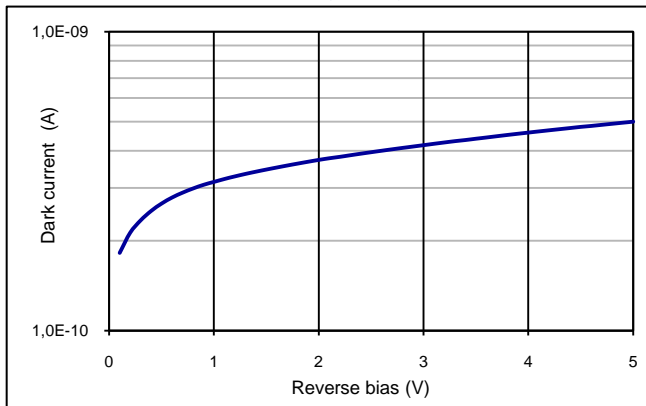

European, International Sales:



First Sensor AG
 Peter-Behrens-Strasse 15
 12459 Berlin
 Germany
 T +49 30 6399 2399
 F +49 30 639923-752
 sales.opto@first-sensor.com

USA:

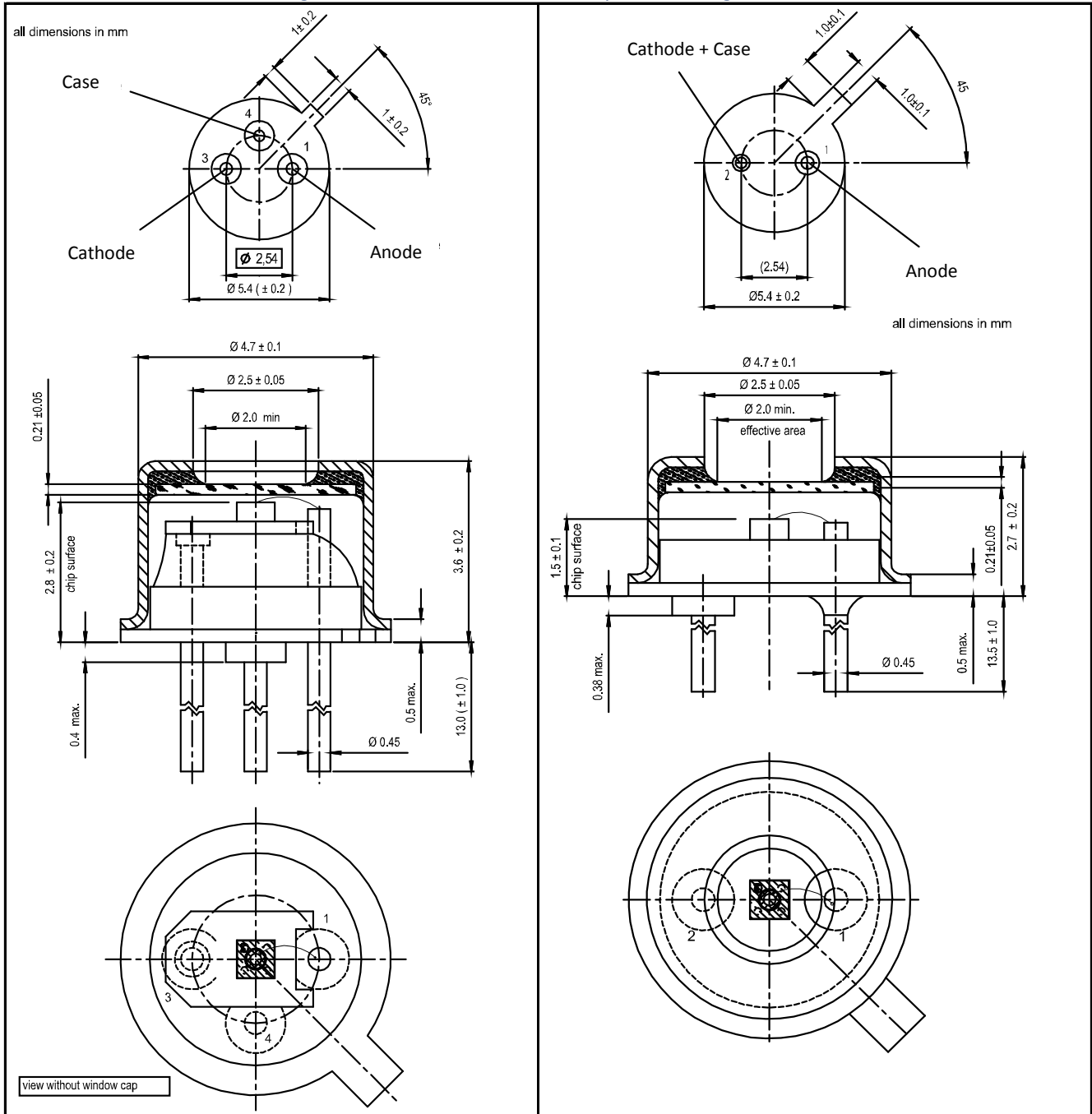

First Sensor Inc.
 5700 Corsa Avenue #105
 Westlake Village
 CA 91362 USA
 T +1 818 706 3400
 F +1 818 889 7053
 sales.us@first-sensor.com

Order number 501203, Package: TO52S1
On request: Package: TO52S3

Package dimension:

Small quantities: Foam pad, boxed (12 cm x 16.5 cm)

Disclaimer: Due to our strive for continuous improvement, specifications are subject to change within our PCN policy according to JESD46C.

European, International Sales:

 First Sensor AG
 Peter-Behrens-Strasse 15
 12459 Berlin
 Germany
 T +49 30 6399 2399
 F +49 30 639923-752
 sales.opto@first-sensor.com

USA:

 First Sensor Inc.
 5700 Corsa Avenue #105
 Westlake Village
 CA 91362 USA
 T +1 818 706 3400
 F +1 818 889 7053
 sales.us@first-sensor.com